

Dycon Housings – Sizing outlines, dimensions & battery capacities

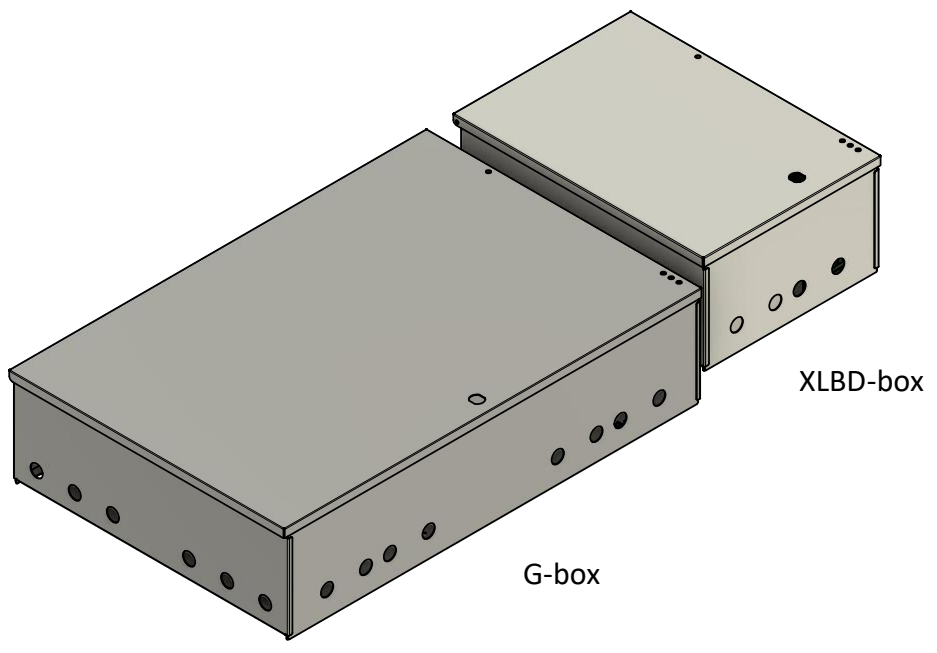

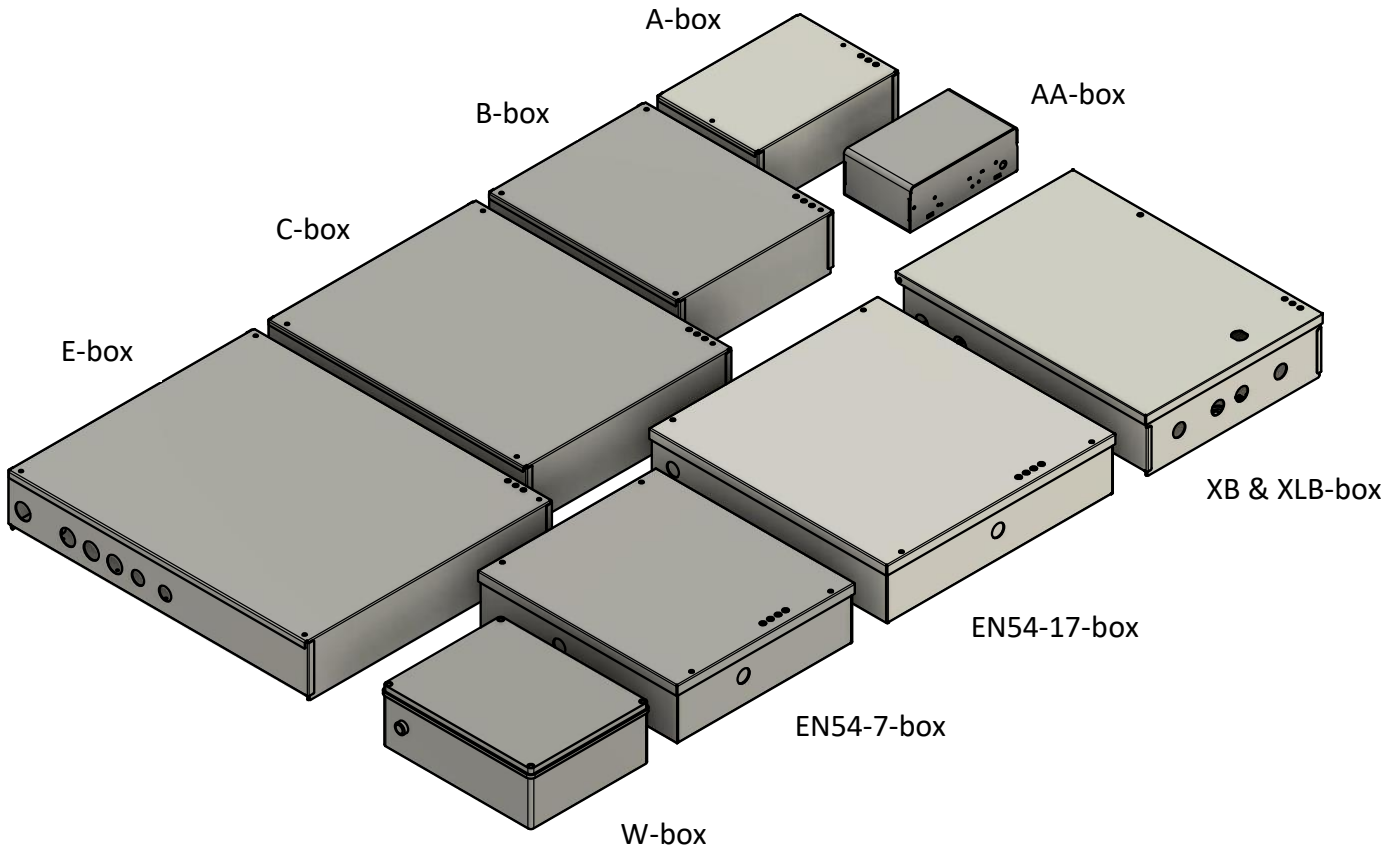

A Box
235 x 170 x 85 mm

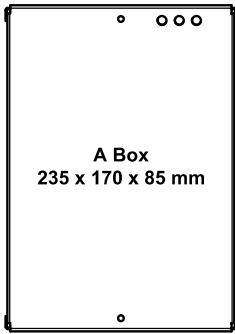
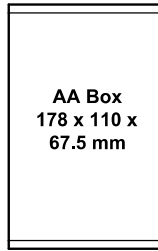

AA Box
178 x 110 x
67.5 mm

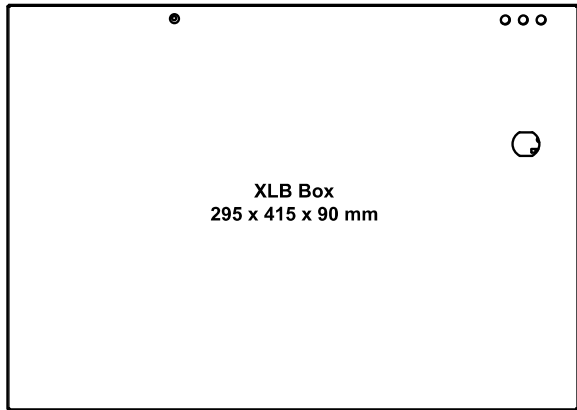

XLB Box
295 x 415 x 90 mm

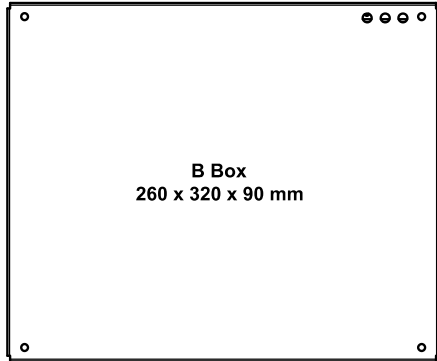

B Box
260 x 320 x 90 mm

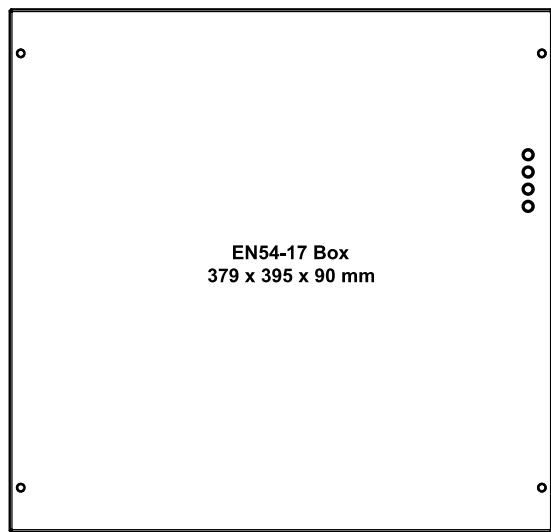

EN54-17 Box
379 x 395 x 90 mm

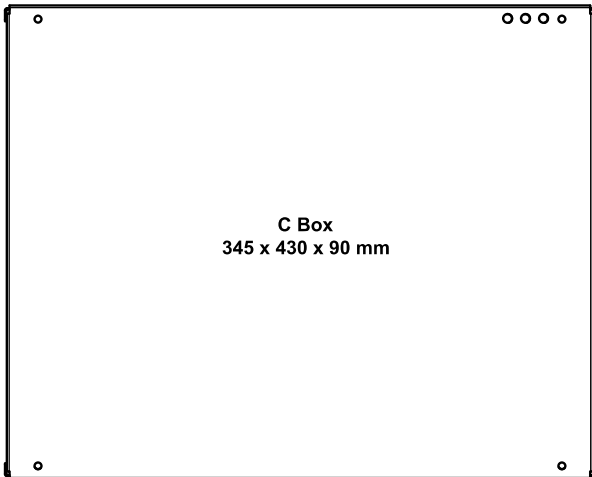

C Box
345 x 430 x 90 mm

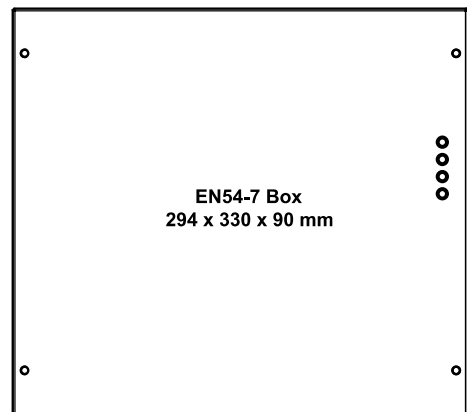

EN54-7 Box
294 x 330 x 90 mm

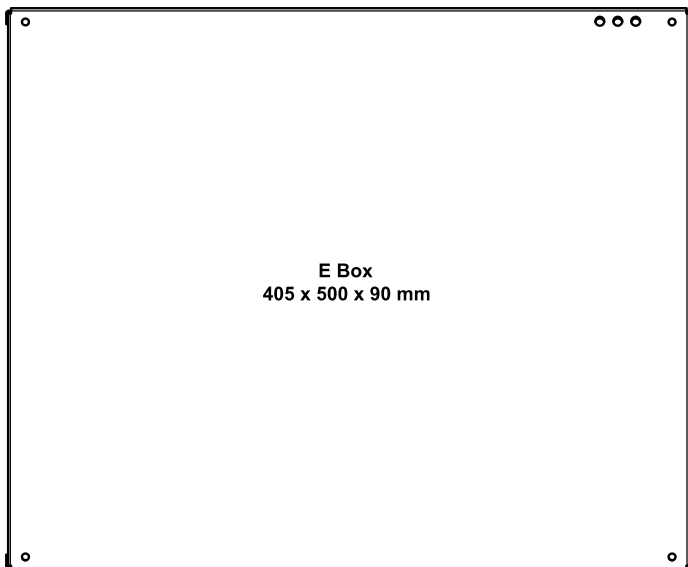

E Box
405 x 500 x 90 mm

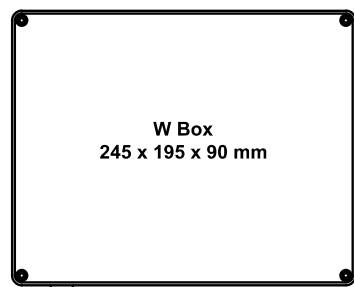

W Box
245 x 195 x 90 mm

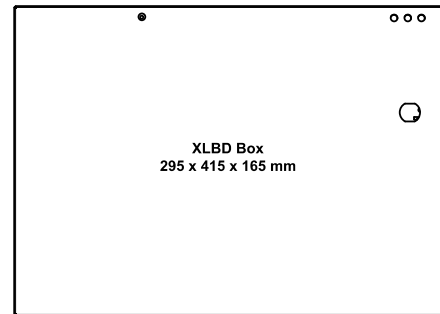
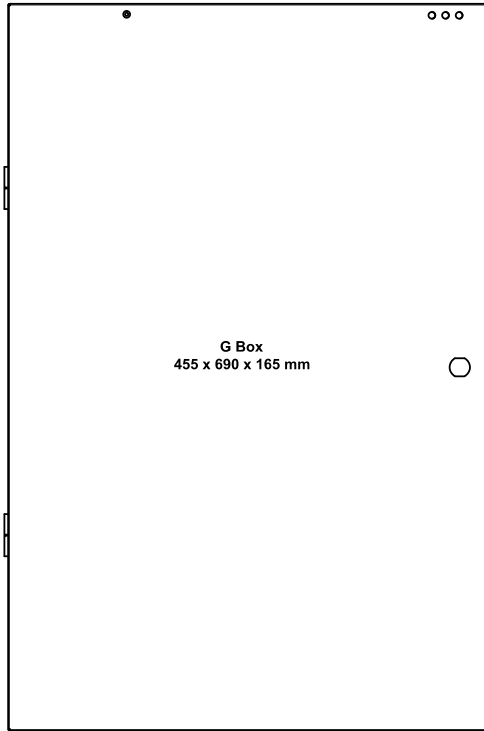

Housing Part No.	Colour	Material	Height	Width	Depth	Weight (without power modules or batteries)	Maximum space available for batteries (see Note *2)
Standard Steel Housings							
AA	White RAL9003	Steel	178mm	110mm	68mm	1.09kg	No battery space
A	White RAL9003	Steel	235mm	170mm	85mm	1.10kg	1 x 7/8Ah
B	White RAL9003	Steel	260mm	320mm	90mm	1.90kg	2 x 7/8Ah or 1 x 17Ah
B-BK	Black RAL9005	Steel	260mm	320mm	90mm	1.90kg	2 x 7/8Ah or 1 x 17Ah
C	White RAL9003	Steel	345mm	430mm	90mm	3.30kg	2 x 7/8Ah or 2 x 17/18Ah
C-BK	Black RAL9005	Steel	345mm	430mm	90mm	3.30kg	2 x 7/8Ah or 2 x 17/18Ah
XB (with clamshell lid)	White RAL9003	Steel	295mm	415mm	90mm	2.20kg	2 x 7/8Ah or 2 x 17/18Ah
XB-BK (with clamshell lid)	Black RAL9005	Steel	295mm	415mm	90mm	2.20kg	3 x 7/8Ah or 2 x 17/18Ah
XLB	White RAL9003	Steel	295mm	415mm	90mm	2.20kg	4 x 7/8Ah or 2 x 17/18Ah
XLB-BK	Black RAL9005	Steel	295mm	415mm	90mm	2.20kg	2 x 7/8Ah or 2 x 17/18Ah
XLBD	White RAL9003	Steel	295mm	415mm	165mm	4.40kg	4 x 17Ah *2
XLBD-BK	Black RAL9005	Steel	295mm	415mm	165mm	4.40kg	4 x 17Ah *2
E	White RAL9003	Steel	405mm	500mm	90mm	5.80kg	2 x 17Ah *2
G	White RAL9003	Steel	690mm	455mm	120mm	8.50kg	2 x 26Ah or 4 x 17Ah *2
G-BK	Black RAL9005	Steel	690mm	455mm	120mm	8.50kg	3 x 26Ah or 4 x 17Ah *2
EN-M7 *1	White RAL9003	Steel	294mm	330mm	90mm	2.50kg	2 x 7/8Ah
EN-L17 *1	White RAL9003	Steel	379mm	395mm	90mm	3.50kg	2 x 17Ah
19" Rack and Mountings							
2U Front plate	Black RAL9005	Steel	482mm	88mm		Overall weight 9.5Kg	*2
2U Main body	Black RAL9005	Steel	440mm	82mm	405mm		
ABS Plastic Climate-Resistant Housing							
W-box (IP65)	Light Grey RAL7035	ABS	245mm	195mm	90mm	1.45kg	1 x 7/8Ah
IP66-Small	Light Grey RAL7035	ABS	180mm	182mm	90mm	0.43kg	1 x 7/8Ah
IP66-Large	Light Grey RAL7035	ABS	295mm	254mm	90mm	0.55kg	1 x 7/8Ah

Key:

*1 = EN54-4 compliant

*2 = The actual number of batteries capable of being housed in any box depends on the size of the main PSU module, the number of system expanders, and the number of 3rd party control modules. Please contact Dycon for more information

Dycon Power Solutions Ltd
Unit A, Cwm Cynon Business Park, Mountain Ash
CF45 4ER, United Kingdom.

For more information about the Dycon products:
website: www.dyconpower.com
email: sales@dyconpower.com

Or to discuss your specific needs: +44 (0)1443 471 900



Dycon leads the security and associated power supply markets, with UK design and manufacture of advanced power products; engineered to provide high quality, cost-effective solutions to meet current regulations and the specific needs of system integrators and end-users.

Designed and manufactured in the UK

Housings dimension table 14032022V10